

Memorandum to the City of Markham Committee of Adjustment

March 17, 2023

File: A/142/22
Address: 21 Seinecliffe Road, Thornhill
Applicant: Andrew Ryu
Agent: EG Engineering Inc (Sean Cho)
Hearing Date: Wednesday, March 22, 2023

The following comments are provided on behalf of the West Team:

The applicant is requesting relief from the following requirements: "Special Residential Second Density (SR2)" of By-law 1767, as amended, as it relates to a proposed gazebo. The variances requested are to permit:

a) By-law 1767, Section 12 (iv)(a):

a flankage setback of 12 ft and 2 in (3.71 m), whereas the By-law requires a setback of 35.0 ft (10.67 m).

BACKGROUND

Property Description

The 1671.39 m² (17990.69 ft²) subject property fronts on the northwest side of Seinecliffe Road and east of Limcombe Drive, north of Steeles Avenue and east of Bayview Avenue. The property is located within an established residential neighbourhood comprised of a mix of one and two-storey detached dwellings.

The subject property contains a two-storey dwelling, which according to assessment records was constructed in 1961. Mature vegetation exists on the property including one large mature tree in the rear yard.

Proposal

The applicant is proposing to construct a gazebo in the rear yard of the property.

Official Plan and Zoning

Official Plan 2014 (partially approved on November 24/17, and updated on April 9/18)

The Official Plan designates the subject property "Residential Low Rise", which provides for low rise housing forms including single detached dwellings. Single detached dwellings are required to meet the general intent of the Official Plan with respect to height, massing, and setbacks. This criteria is established to ensure that the development is appropriate for the site and generally consistent with the zoning requirements for adjacent properties and properties along the same street, while accommodating a diversity of building styles. Regard shall also be had for the retention and enhancement of existing trees and vegetation.

Zoning By-Law 1767

The subject property is zoned "Special Residential Second Density (SR2)" under By-law 1767, as amended, which permits single detached dwellings. The proposed development does not comply with the By-law with respect to the proposed flankage yard setback.

Zoning Preliminary Review (ZPR) Not Undertaken

The owner has confirmed that a Zoning Preliminary Review (ZPR) has not been conducted. However, the applicant has received comments from the building department through their permit process to confirm the variances required for the proposed development.

COMMENTS

The Planning Act states that four tests must be met in order for a variance to be granted by the Committee of Adjustment:

- a) The variance must be minor in nature;
- b) The variance must be desirable, in the opinion of the Committee of Adjustment, for the appropriate development or use of land, building or structure;
- c) The general intent and purpose of the Zoning By-law must be maintained;
- d) The general intent and purpose of the Official Plan must be maintained.

Reduced Flankage Yard Setback Variance

The applicant is requesting relief to permit a minimum flankage yard setback of 12 ft and 2 in (3.71 m), whereas a minimum flankage yard setback of 35.0 ft (10.67 m) is permitted. The requested variance is generally consistent with the existing dwelling side yard setback pattern fronting Limcombe Drive. Staff are of the opinion that there are no anticipated adverse impacts to the abutting properties and have no concerns with the requested variance.

Tree Protection and Compensation

Tree Preservation Staff identified a tree of concern located at the rear of the property where the proposed gazebo is planned for construction (Refer to Appendix "B" – Plans, Partial Layout Plan). A tree protection barrier is required to mitigate impact for the tree of concern. Staff recommend that the tree related conditions be adopted with any approval of this application, to ensure that the applicant installs the appropriate tree protection barriers, and provides compensation to the City.

PUBLIC INPUT SUMMARY

No written submissions were received as of March 16 2023. It is noted that additional information may be received after the writing of the report, and the Secretary-Treasurer will provide information on this at the meeting.

CONCLUSION

Planning Staff have reviewed the application with respect to Section 45(1) of The Planning Act, R.S.O. 1990, c. P.13, as amended, and are of the opinion that the variance request meets the four tests of the Planning Act and have no objection. Staff recommend that the Committee consider public input in reaching a decision.

The onus is ultimately on the applicant to demonstrate why they should be granted relief from the requirements of the zoning by-law, and how they satisfy the tests of the Planning Act required for the granting of minor variances.

Please refer to Appendix "A" for conditions to be attached to any approval of this application.

APPENDICES

Appendix "A" – Conditions of Approval

Appendix "B" – Plans

PREPARED BY:



Trisha Sridharan, Development Technician, Zoning and Special Projects

REVIEWED BY:



Rick Cefaratti, MCIP, RPP, Senior Planner II, West District

File Path: Amanda\File\ 22 252686 \Documents\District Team Comments Memo

APPENDIX "A"

CONDITIONS TO BE ATTACHED TO ANY APPROVAL OF FILE A/142/22

1. The variances apply only to the proposed development as long as it remains;
2. That the variances apply only to the proposed development, in substantial conformity with the batch stamped plans attached as Appendix "B" to this Staff Report, and that the Secretary-Treasurer receive written confirmation that this condition has been fulfilled to the satisfaction of the Director of Planning and Urban Design, or their designate;
3. That prior to the commencement of construction or demolition, tree protection be erected and maintained around all trees on site in accordance with the City's Streetscape Manual, including street trees, in accordance with the City's Streetscape Manual (2009) as amended, and inspected by City Staff to the satisfaction of the Tree Preservation Technician or Manager of By-law Enforcement & Regulatory Services Division.

CONDITIONS PREPARED BY:



Trisha Sridharan, Development Technician, Zoning and Special Projects

Schedule "C"

The Ontario Land Registry Act and the Ontario Land Titles Act require that all land in Ontario be registered in the Land Registry Office. The Registrar of Land Titles has the honor to advise you that the above described land is registered in the Land Registry Office under the name of the person named in the Schedule "C" of the Land Registry Office. The Registrar of Land Titles has the honor to advise you that the above described land is registered in the Land Registry Office under the name of the person named in the Schedule "C" of the Land Registry Office.

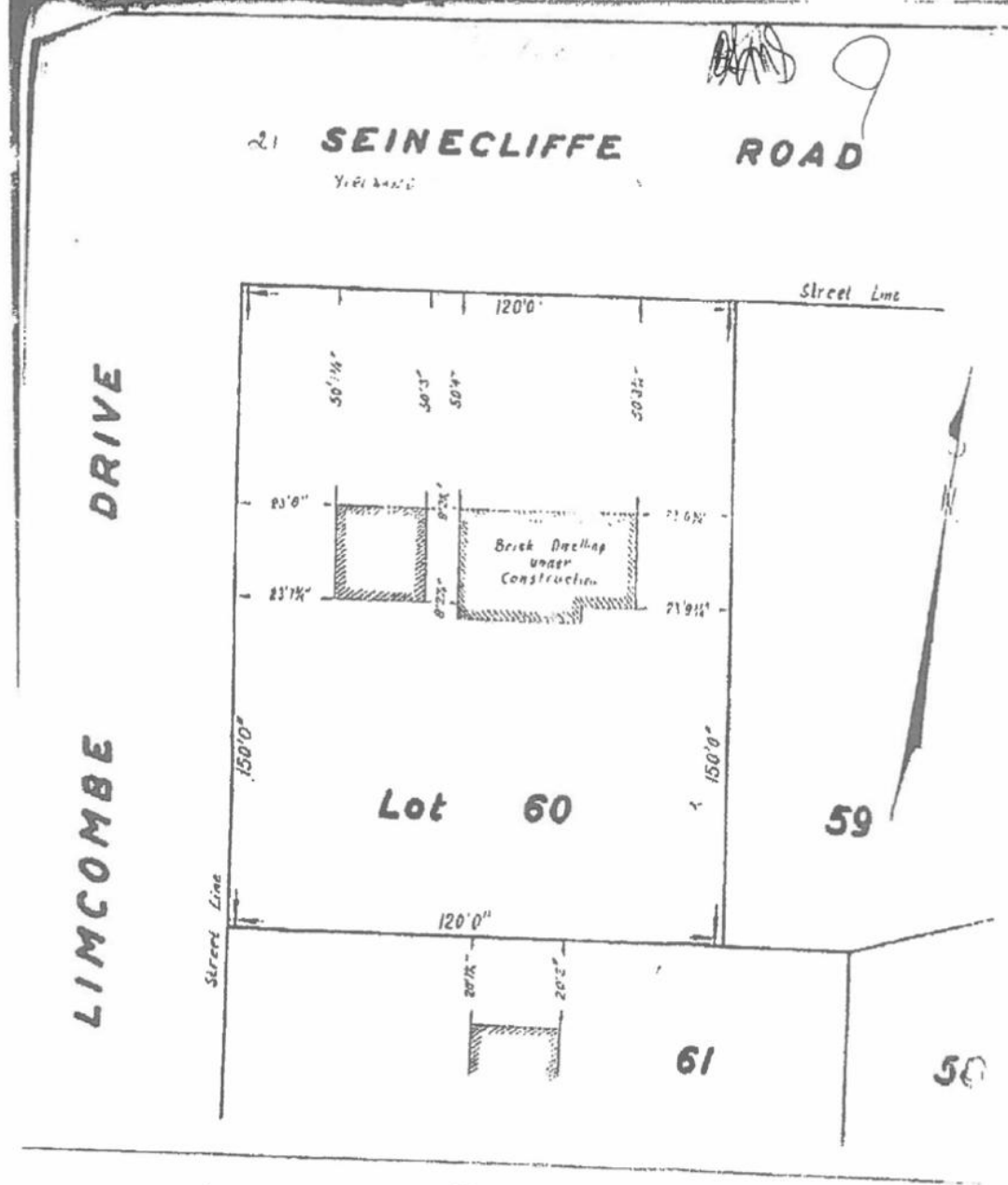

[Handwritten signature]

Plan showing
Lot 60
Plan M 896
 Township of Markham - County of York

[Handwritten signature] 9

Appendix B

File: 22.252686.000.00.MNV
 Date: 03/17/23
 MM/DD/YY

NO.	DESCRIPTION	DATE
1		5/2/2022

EG
 EG Engineering Inc.
EG ENGINEERING INC.
 40 ALDESSO DRIVE, VAUGHAN, ON SUITE L4K3C3
 TEL: (905) 474-1100

21 Seinecliffe Rd.
 Thornhill, ON

DRAWING
SURVEY PLAN

SCALE N.T.S.	PROJECT NO. 0000	DRAWING NO. A-0.1
DRAWN SC	CHKD	DATE 2/25/2022

REFERENCE ONLY

1 SURVEY PLAN
 A0.1 SCALE: N.T.S.

Appendix B

File: 22.252686.000.00.MNV

Date: 03/17/23
MM/DD/YY

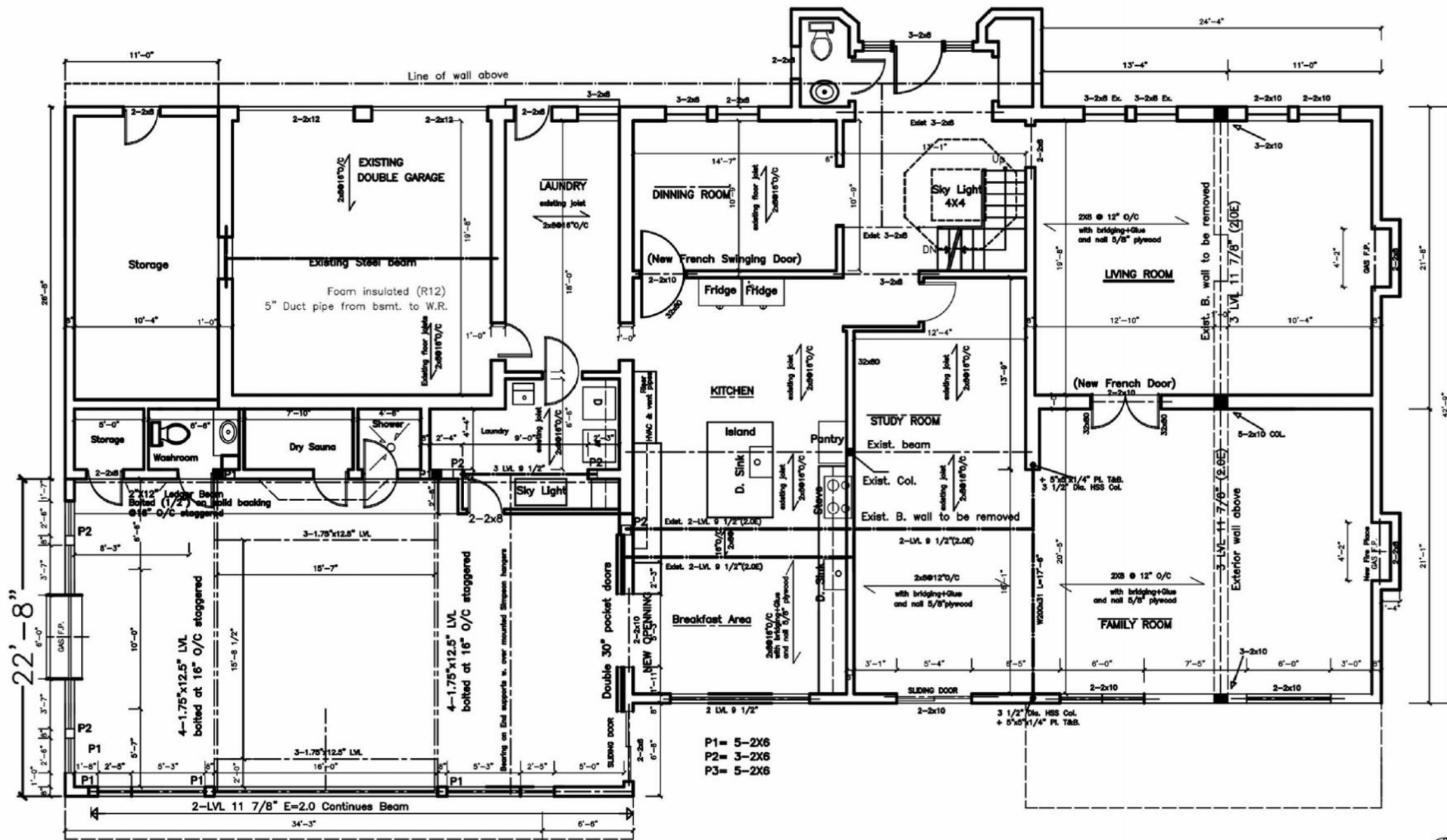

REFERENCE ONLY

1 EXISTING MAIN FLOOR PLAN
A0.2 SCALE: N.T.S.

NO.	DESCRIPTION	DATE
1		8 / 24 / 2022

EG
EG Engineering Inc.

EG ENGINEERING INC.
40 ALDESSO DRIVE, VAUGHAN, ON SUITE L4K3C3
TEL: (905) 474-1100

21 Seinecliffe Rd.

Thornhill, ON

DRAWING
EXISTING MAIN FLOOR PLAN

SCALE N.T.S.	PROJECT NO. 0000	DRAWING NO. A-0.2
DRAWN SC	CHKD	DATE 2 / 25 / 2022

Appendix B

File: 22.252686.000.00.MNV

Date: 03/17/23
MM/DD/YY

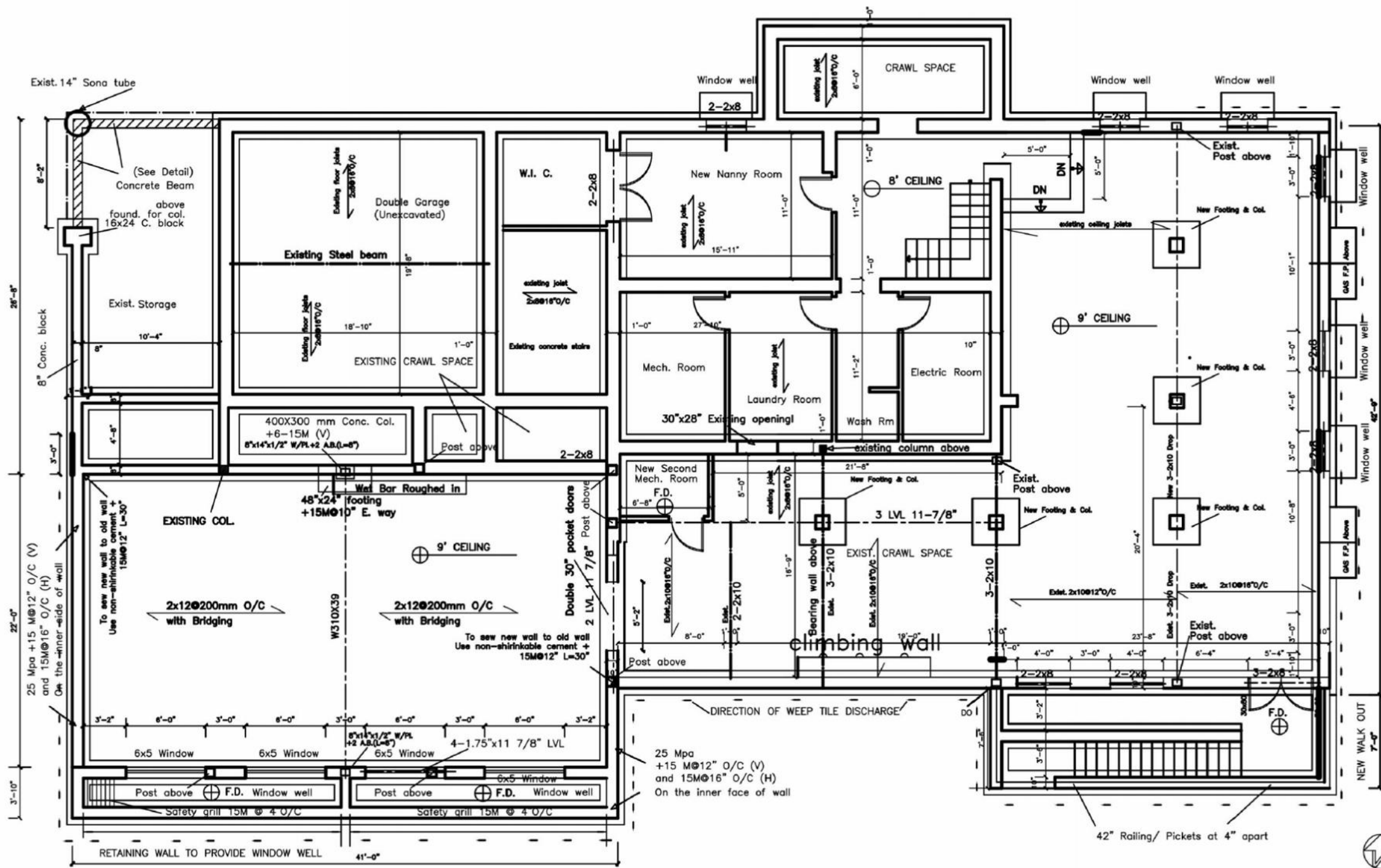

REFERENCE ONLY

1 BASEMENT PLAN
A0.3 SCALE: N.T.S.

NO.	DESCRIPTION	DATE
1		8 / 24 / 2022



EG ENGINEERING INC.
40 ALDESSO DRIVE, VAUGHAN, ON SUITE L4K3C3
TEL: (905) 474-1100

21 Seinecliffe Rd.

Thornhill, ON

NAME

DRAWING
BASEMENT PLAN

SCALE N.T.S.	PROJECT NO. 0000	DRAWING NO. A-0.3
DRAWN SC	CHKD	DATE 2 / 25 / 2022

Appendix B

File: 22.252686.000.00.MNV

Date: 03/17/23
MM/DD/YY

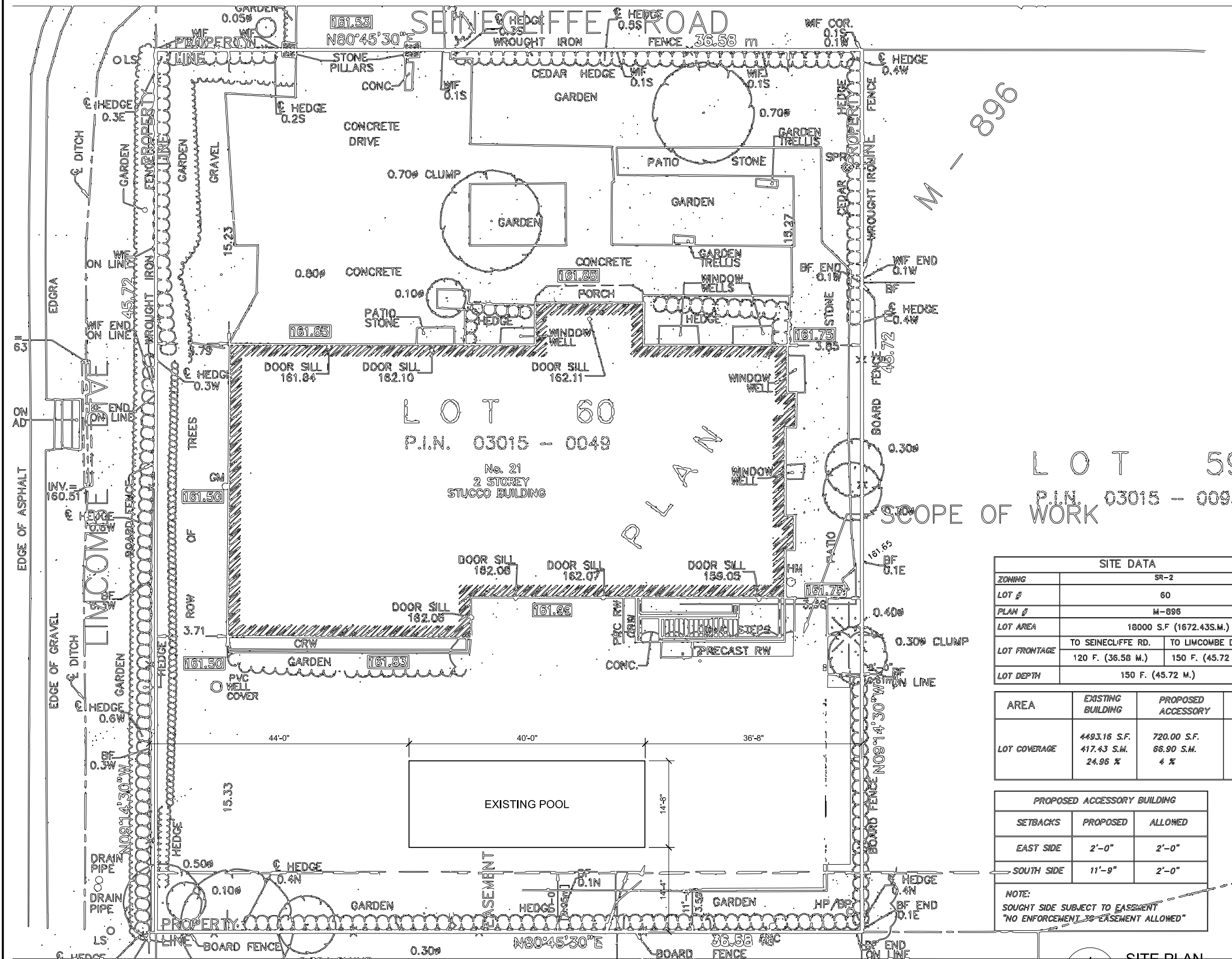

SITE DATA	
ZONING	SR-2
LOT #	60
PLAN #	M-896
LOT AREA	18000 S.F. (1672.43S.M.)
LOT FRONTAGE	TO SEINECLIFFE RD. TO LIMCOMBE DRIVE
	120 F. (36.58 M.) 150 F. (45.72 M.)
LOT DEPTH	150 F. (45.72 M.)

AREA	EXISTING BUILDING	PROPOSED ACCESSORY	TOTAL	ALLOWED
LOT COVERAGE	4493.16 S.F. 417.43 S.M. 24.96 %	720.00 S.F. 66.90 S.M. 4 %	5213.16 S.F. 484.32 S.M. 28.96 %	5994 S.F. 556.86 S.M. 33.3 %

PROPOSED ACCESSORY BUILDING		
SETBACKS	PROPOSED	ALLOWED
EAST SIDE	2'-0"	2'-0"
SOUTH SIDE	11'-9"	2'-0"

NOTE:
SOUGHT SIDE SUBJECT TO EASEMENT
"NO ENFORCEMENT TO EASEMENT ALLOWED"



1 SITE PLAN
A1 SCALE: N.T.S.

NO.	DESCRIPTION	DATE
1		5/2/2022



EG ENGINEERING INC.
40 ALDESSO DRIVE, VAUGHAN, ON SUITE L4K3C3
TEL: (905) 474-1100

21 Seinecliff Rd.

Thornhill, ON

DRAWING NAME
SITE PLAN

SCALE	PROJECT NO.	DRAWING NO.
N.T.S.	0000	A-1
DRAWN	CHKD	DATE
SC		2/25/2022

Appendix B

File: 22.252686.000.00.MNV

Date: 03/17/23
MM/DD/YY

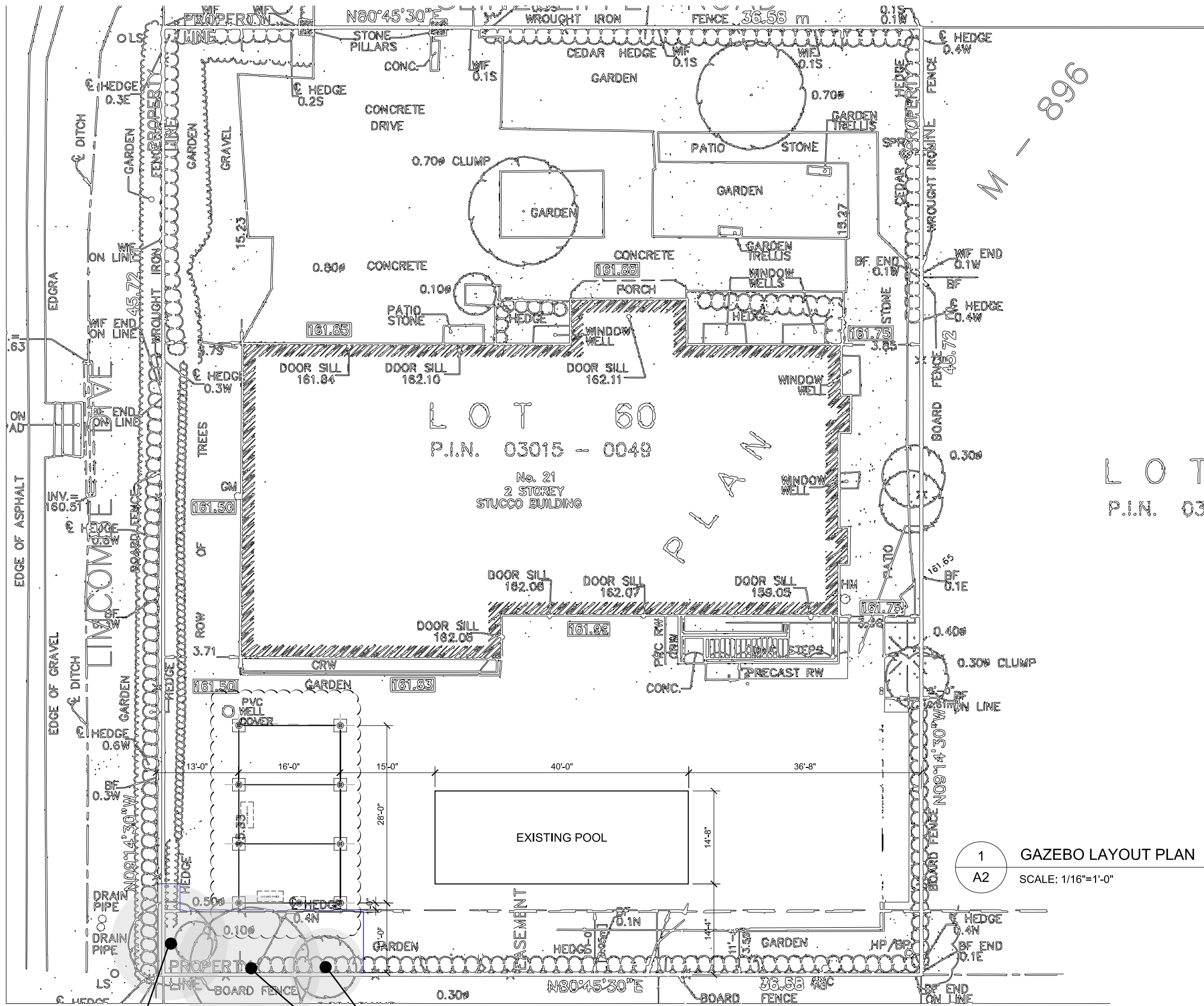

LOT 60
P.I.N. 03015 -- 0049

No. 21
2 STOREY
STUCCO BUILDING

LOT
P.I.N. 030

1 GAZEBO LAYOUT PLAN
A2 SCALE: 1/16"=1'-0"

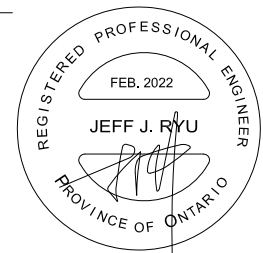

NO.	DESCRIPTION	DATE
1		5/2/2022

EG Engineering Inc.
40 ALDESSO DRIVE, VAUGHAN, ON SUITE L4K3C3
TEL: (905) 474-1100

21 Seinedcliffe Rd.
Thornhill, ON

DRAWING		PROJECT NO.		DRAWING NO.	
LAYOUT PLAN		0000		A-2	
SCALE	1/16"=1'-0"	DATE	2/25/2022		
DRAWN	SC	CHKD			

Tree #10 Tree #9 Tree #8

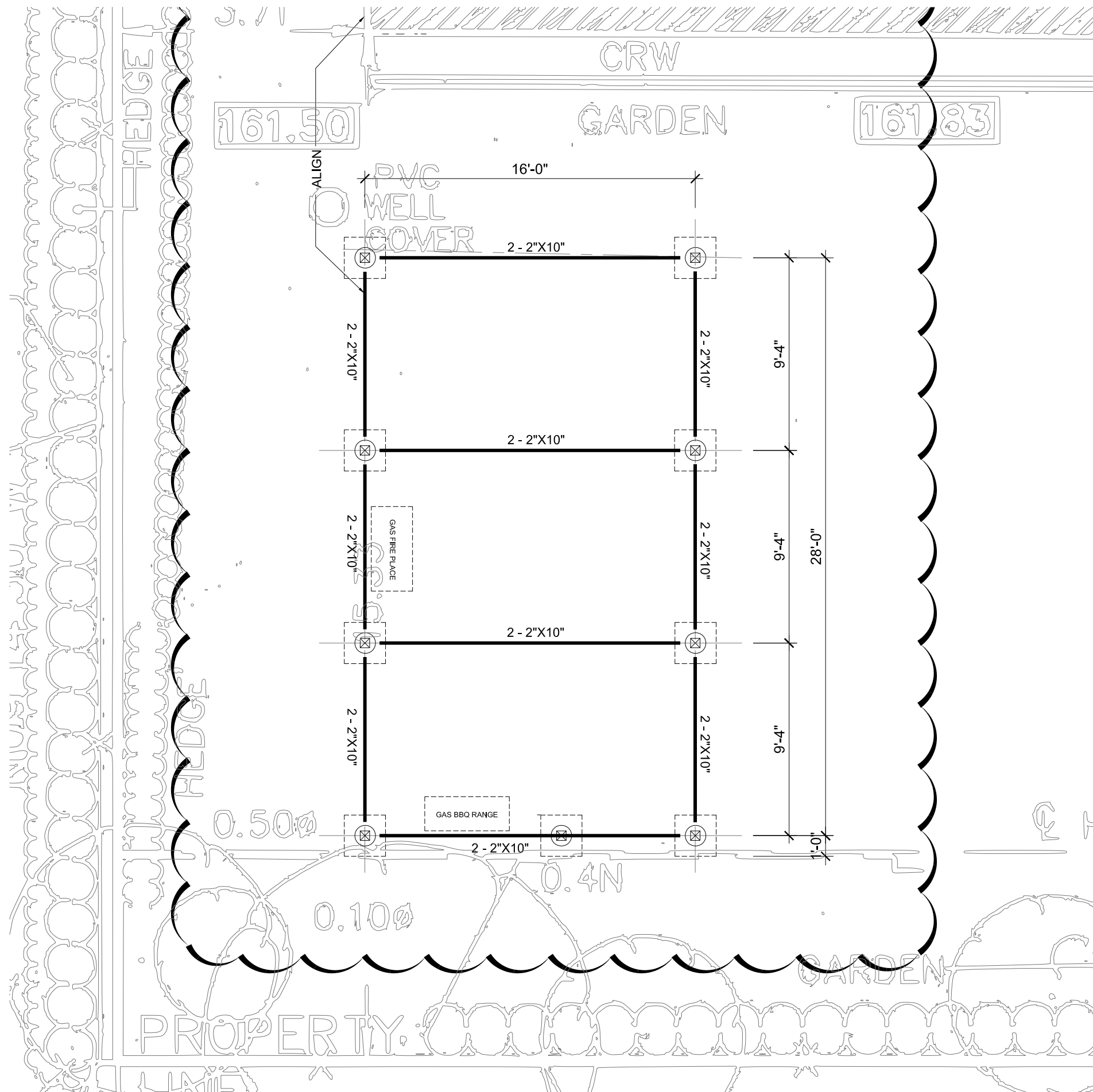

Appendix B

File: 22.252686.000.00.MNV

Date: 03/17/23
MM/DD/YY

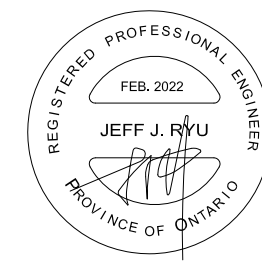

1 PARTIAL LAYOUT PLAN
A3 SCALE: 3/16"=1'-0"

1		5 / 2 / 2022
NO.	DESCRIPTION	DATE
EG ENGINEERING INC. 40 ALDESSO DRIVE, VAUGHAN, ON SUITE L4K3C3 TEL: (905) 474-1100		
21 Seinedcliffe Rd.		
Thornhill, ON		
DRAWING		
PARTIAL LAYOUT PLAN		
SCALE 3/16"=1'-0"	PROJECT NO. 0000	DRAWING NO.
DRAWN SC	CHKD	DATE 2 / 25 / 2022
		A-3

Appendix B

File: 22.252686.000.00.MNV

Date: 03/17/23
MM/DD/YY

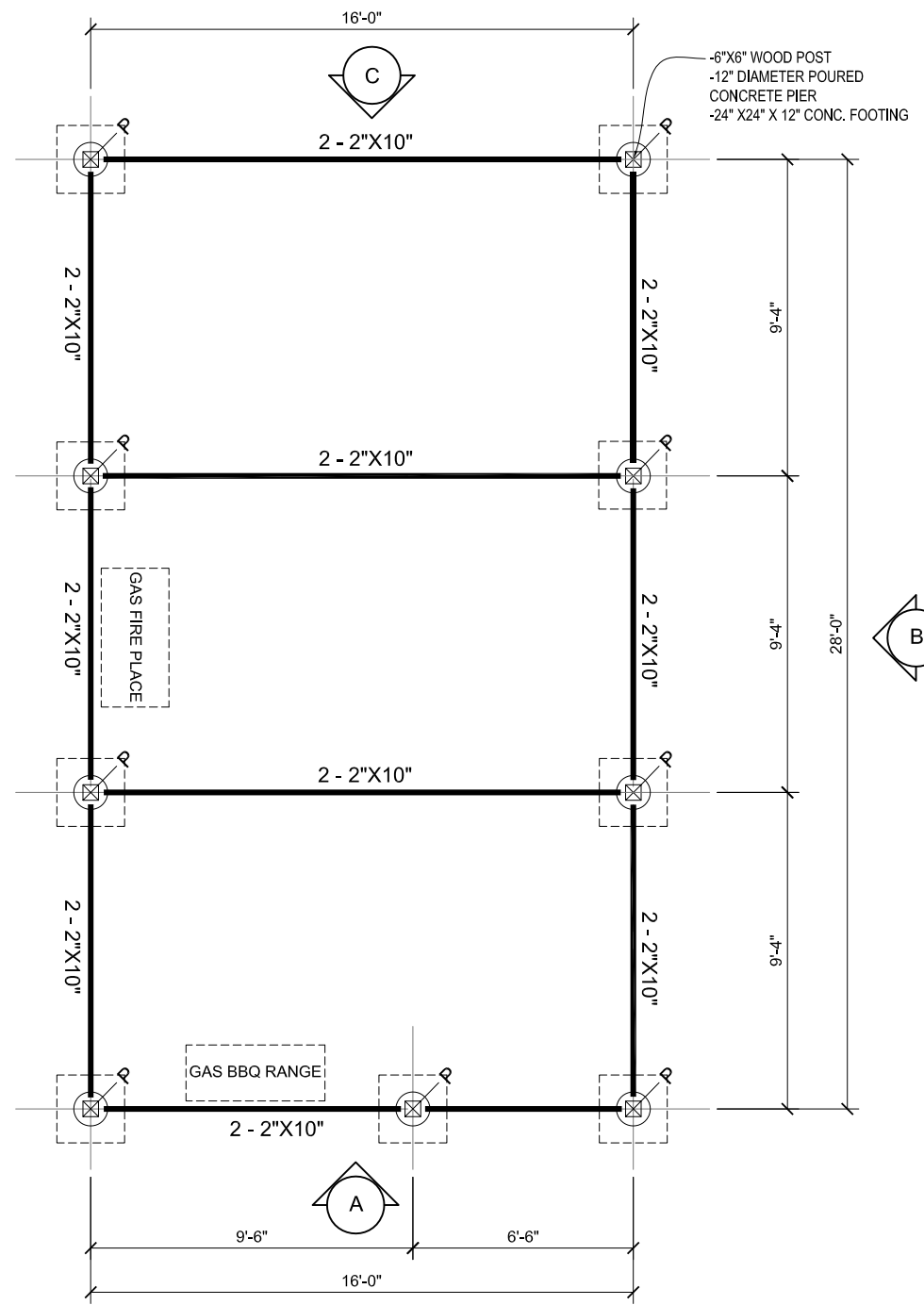

1 PLAN VIEW
A4 SCALE: 3/16"=1'-0"

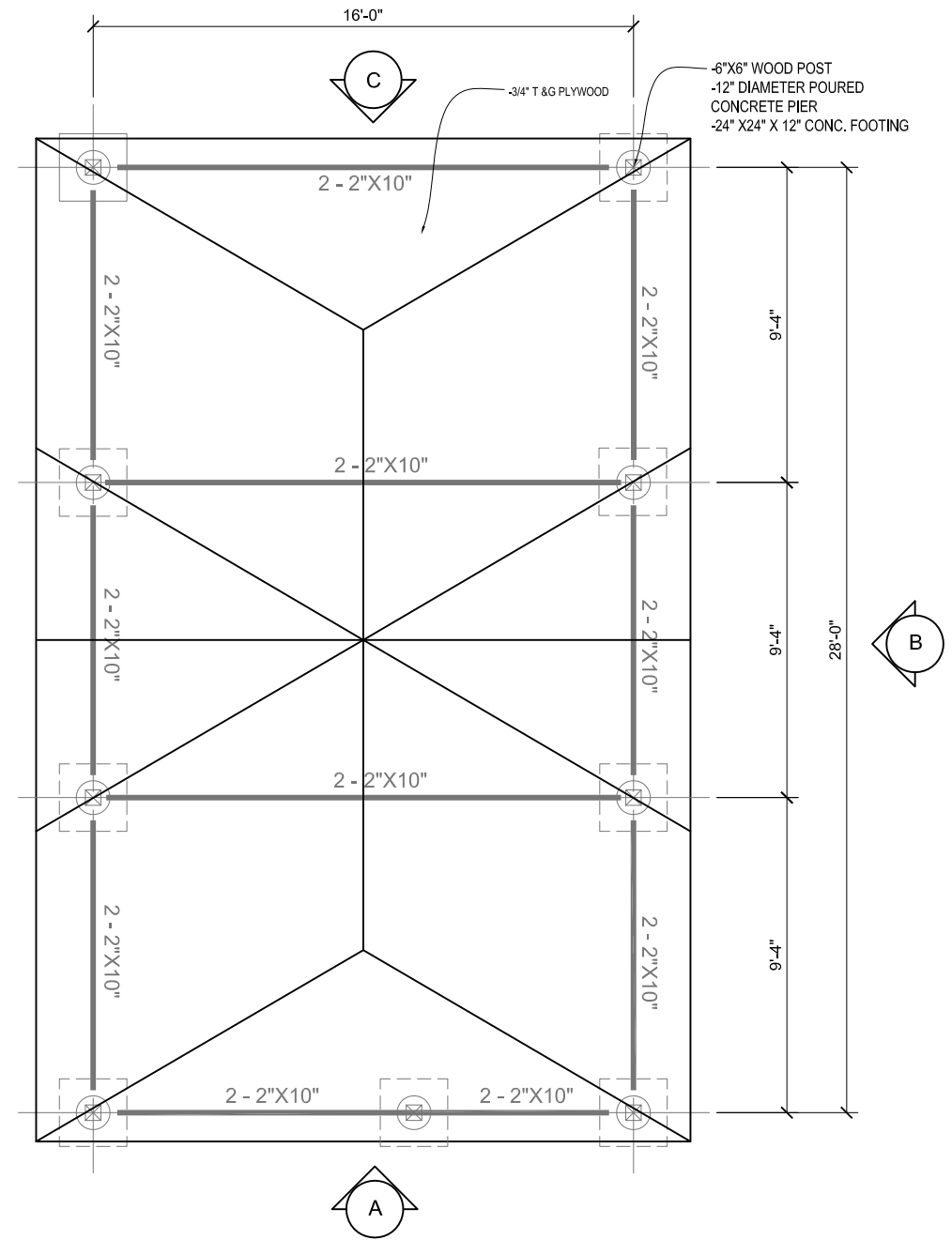

2 ROOF PLAN
A4 SCALE: 3/16"=1'-0"

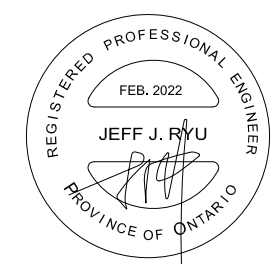

NO.	DESCRIPTION	DATE
1		5/2/2022

EG
EG Engineering Inc.
EG ENGINEERING INC.
40 ALDESSO DRIVE, VAUGHAN, ON SUITE L4K3C3
TEL: (905) 474-1100

21 Seinedcliffe Rd.
Thornhill, ON

PARTIAL PLAN & ROOF PLAN

SCALE 3/16"=1'-0"	PROJECT NO. 0000	DRAWING NO. A-4
DRAWN SC	CHKD	DATE 2/25/2022

Appendix B

File: 22.252686.000.00.MNV

Date: 03/17/23
MM/DD/YY

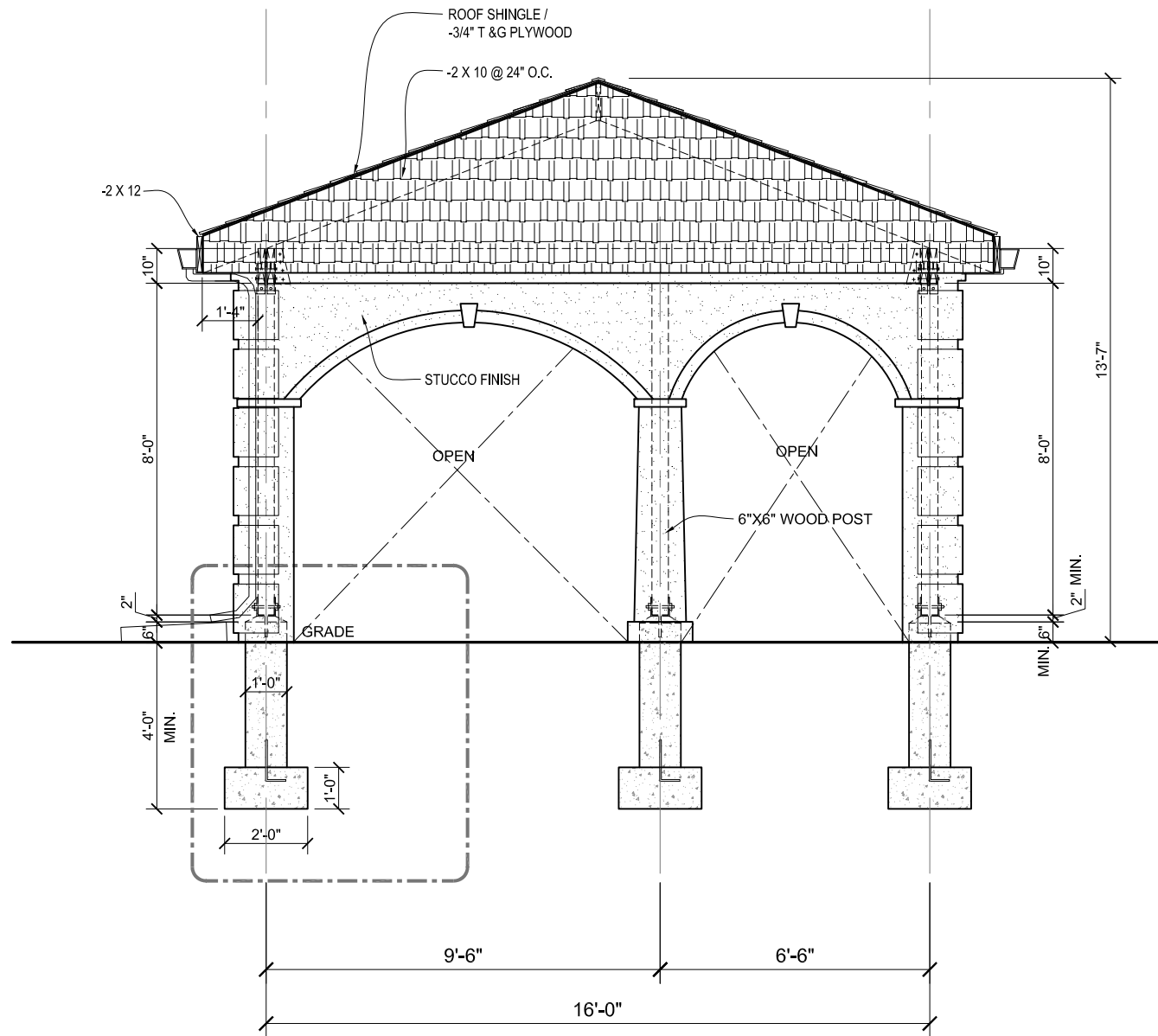

1 ELEVATION-A
A5 SCALE: 1/4"=1'-0"

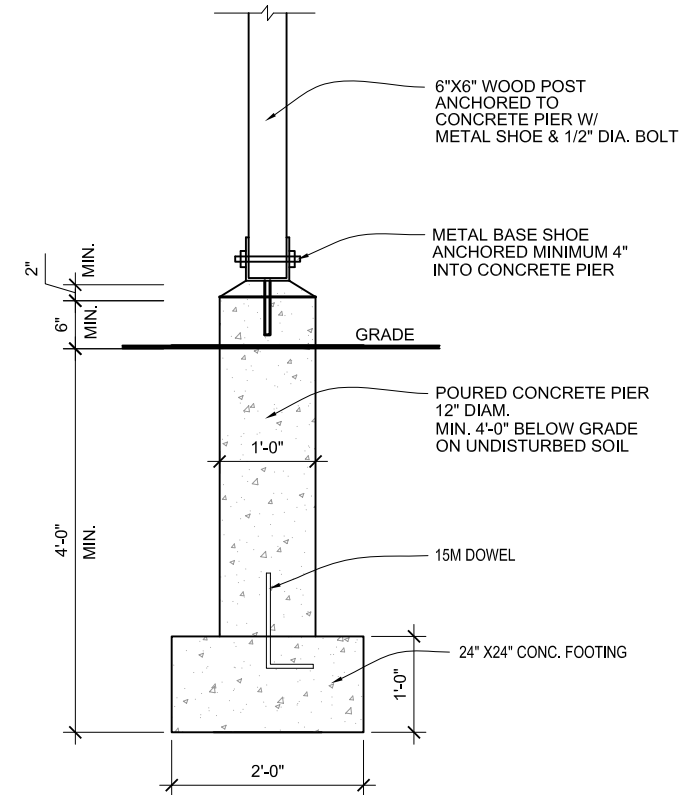

2 FOOTING DETAILS
A5 SCALE: 1/2"=1'-0"



NO.	DESCRIPTION	DATE
1		5 / 2 / 2022



EG ENGINEERING INC.
40 ALDESSO DRIVE, VAUGHAN, ON SUITE L4K3C3
TEL: (905) 474-1100

21 Seinecliffe Rd.

Thornhill, ON

NAME

DRAWING
ELEVATION-A

SCALE	PROJECT NO.	DRAWING NO.
AS SHOWN	0000	A-5
DRAWN	CHKD	DATE
SC		2 / 25 / 2022

Appendix B

File: 22.252686.000.00.MNV

Date: 03/17/23
MM/DD/YY

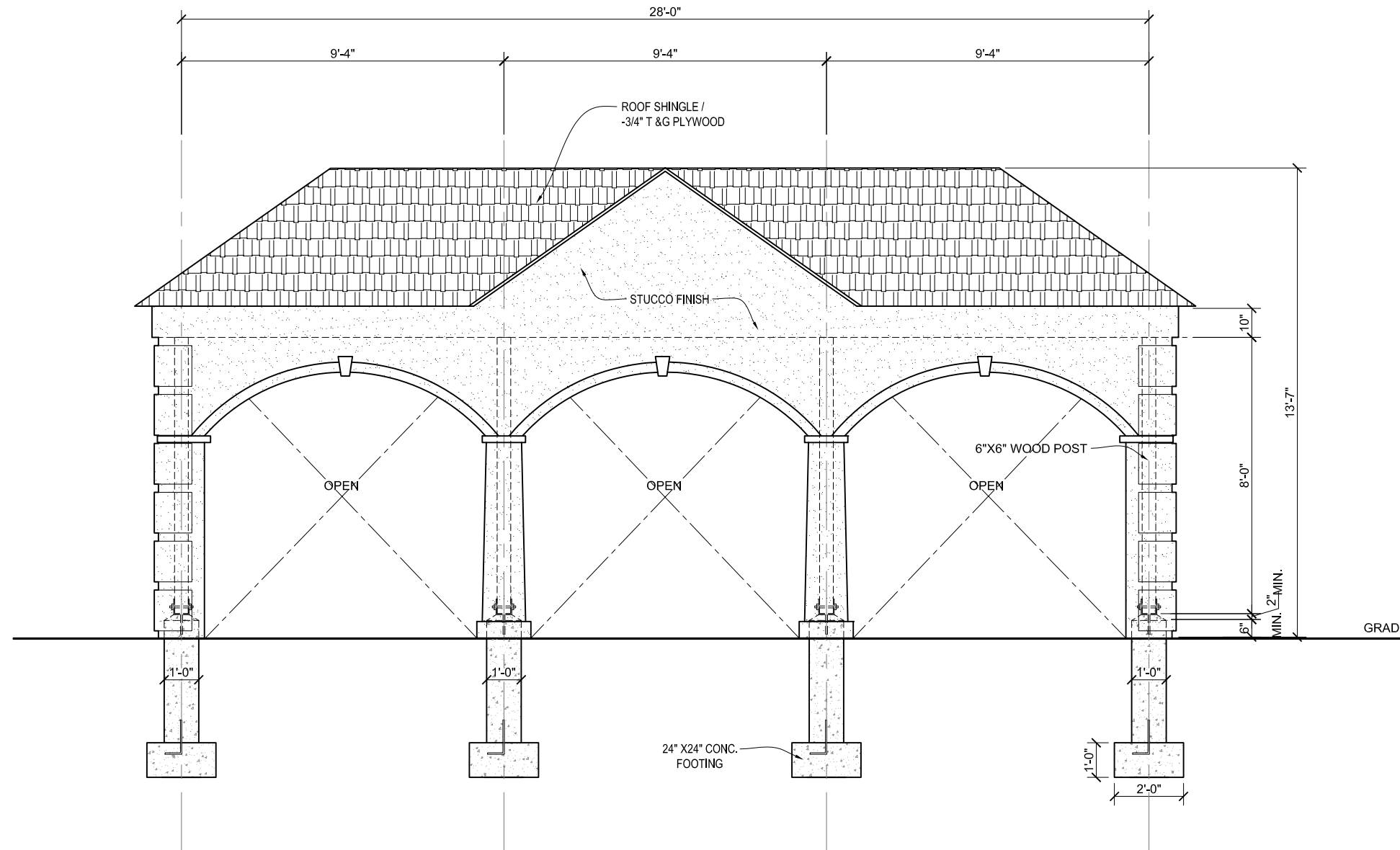

1 ELEVATION-B
A6 SCALE: 1/4"=1'-0"



NO.	DESCRIPTION	DATE
1		5 / 2 / 2022

EG
EG Engineering Inc.
EG ENGINEERING INC.
40 ALDESSO DRIVE, VAUGHAN, ON SUITE L4K3C3
TEL: (905) 474-1100

21 Seinedcliffe Rd.
Thornhill, ON

DRAWING		ELEVATION-B	
SCALE	PROJECT NO.	DRAWING NO.	
1/4"=1'-0"	0000	A-6	
DRAWN	CHKD	DATE	
SC		2 / 25 / 2022	

Appendix B

File: 22.252686.000.00.MNV

Date: 03/17/23
MM/DD/YY

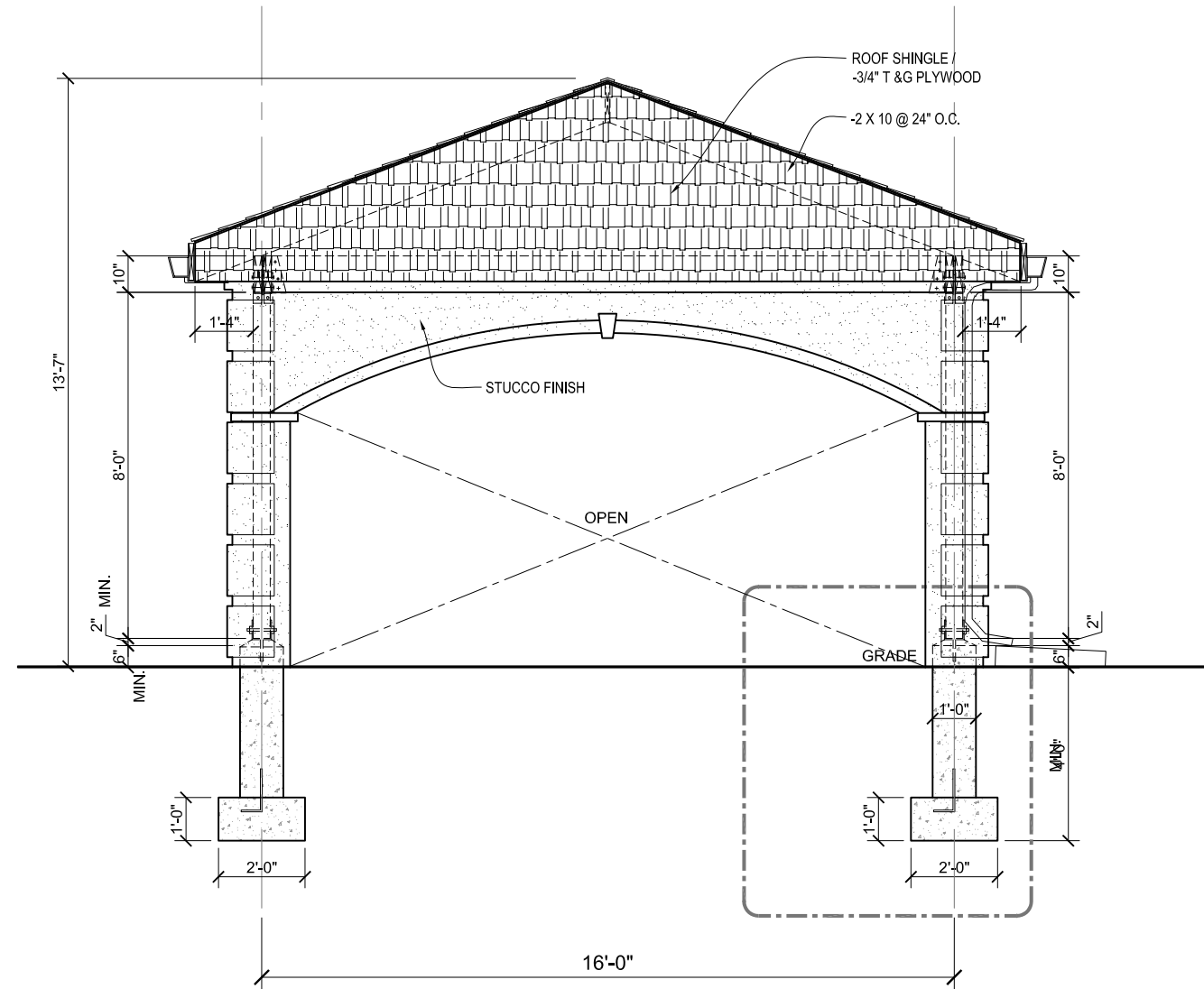

1 ELEVATION-C
A7 SCALE: 1/4"=1'-0"



NO.	DESCRIPTION	DATE
1		5 / 2 / 2022



EG ENGINEERING INC.
40 ALDESSO DRIVE, VAUGHAN, ON SUITE L4K3C3
TEL: (905) 474-1100

21 Seinedcliffe Rd.

Thornhill, ON

NAME
DRAWING
ELEVATION-C

SCALE 1/4"=1'-0"	PROJECT NO. 0000	DRAWING NO. A-7
DRAWN SC	CHKD	DATE 2 / 25 / 2022

Appendix B

File: 22.252686.000.00.MNV

Date: 03/17/23
MM/DD/YY

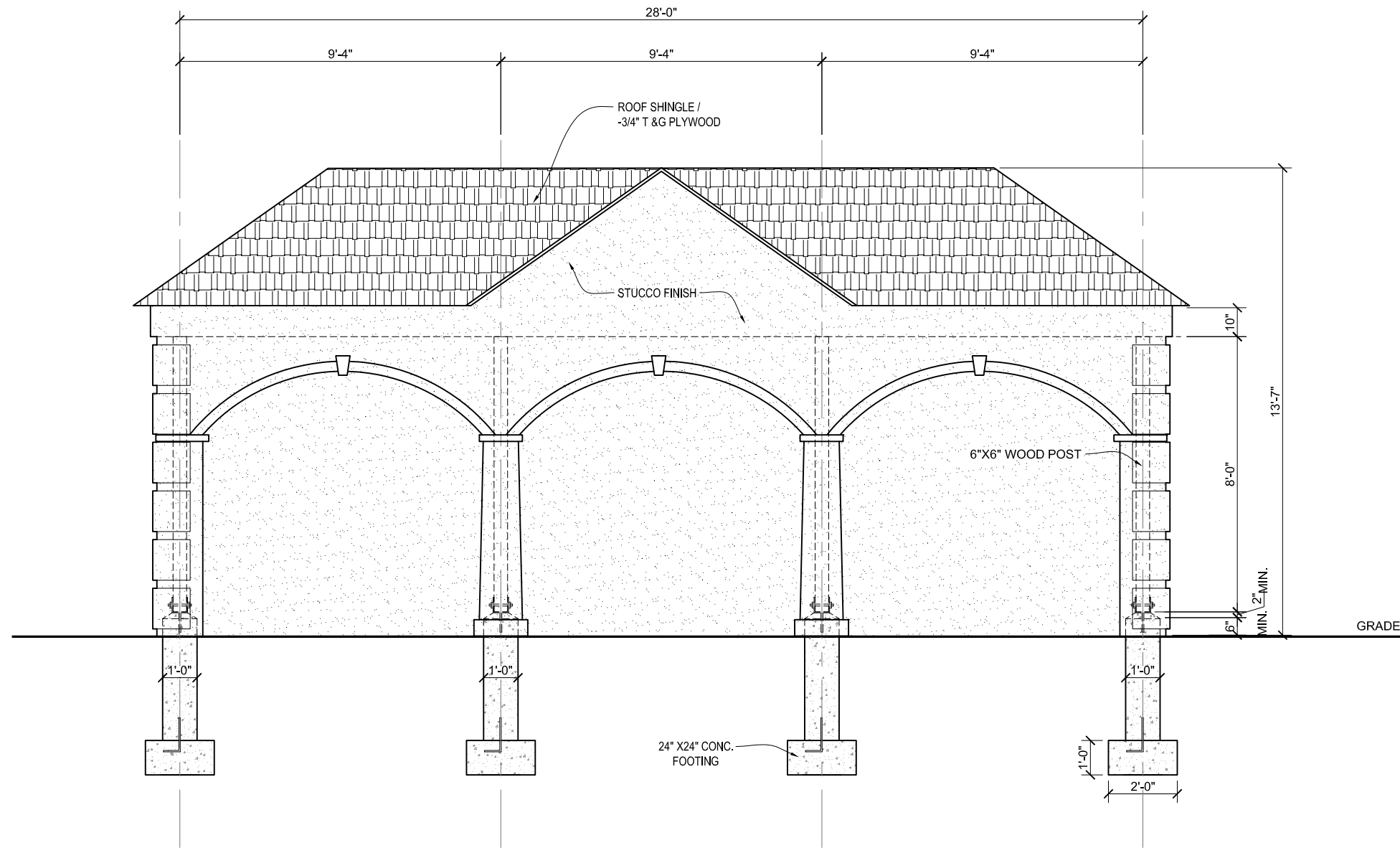

1 ELEVATION-D
A8 SCALE: 1/4"=1'-0"



NO.	DESCRIPTION	DATE
1		5 / 2 / 2022



EG ENGINEERING INC.
40 ALDESSO DRIVE, VAUGHAN, ON SUITE L4K3C3
TEL: (905) 474-1100

21 Seinecliffe Rd.

Thornhill, ON

NAME

DRAWING
ELEVATION-D

SCALE	PROJECT NO.	DRAWING NO.
1/4"=1'-0"	0000	A-8
DRAWN	CHKD	DATE
SC		2 / 25 / 2022